

**New!**

# Clear View II Defroster Instruction Attachment Two

[www.frostfighter.com](http://www.frostfighter.com)
**2**

<b>Defroster Data</b>	<b>Part Number: 1202-1725-L</b>		
Drawing			
Description	<i>Clear View Defrosters clear mist, snow and ice even in the most challenging winter conditions. These defrosters feature proven heating performance, a professional factory look and are available in hundreds of sizes including 12 and 24 volt systems.</i>		
Overall Height	4.0 in (10.6 cm)	Modulation*	6 %
Element Height	1 1/4 in (3.17 cm)	Timer Standard	10 Minutes
Elements	2 (1 roll x 2 line x 31 in)	Alt. Times*	20, 40, 80, 160, Manual
Tab Location	Left	* Requires ThermaSync 2812/2814 series defroster controls	
Fuse	7.5 Amp		
Voltage	12 V		
Length	Min. 17 in (43 cm)	Max. 25 in (64 cm)	
Currents (Amp)			
Peak	20.4 A	13.8 A	
RMS	3.4	0.9	
Avg	1.3	7.5	
Stick Kit	-		
Document	11/18/2013		



**PLEASE READ THIS PAGE**

## Clear View instructions come in two parts

Clear View defrosters are high performance devices and rely on accurate installation to reliably melt snow and ice.

These instructions come in two parts, General Instructions and Attachment Two which is specific to each defroster.



Clear View Defrosters must be installed EXACTLY as shown in the instructions including Attachment Two.

Failure to follow the instructions will cause the defroster or control to fail and **voids any and all warranty and replacement policies.**

**Read the instructions carefully before beginning the installation**

## Of special importance when installing Clear View Defrosters:

### Select a defroster that fits the window

Respect the minimum and maximum allowed widths for the defroster.

### All heating elements delivered with the kit **MUST** be used

Adding or removing heating elements from will cause the defroster to fail.

### Follow the defrosters bus bar layout exactly

The elements per buss bar and tab locations cannot be changed.

### Make sure the window is **CLEAN** and **DRY** before installing

Use the GAP-1 adhesion promoter supplied.

### Apply the defroster grid at temperatures above 60° F (16° C)

This helps the bonding tape to cure properly.

### Review both the General Instructions and Attachment Two

Do not rush into the installation. Review both instructions before starting installation.

**This attachment shows the defroster layout.**

**Do not change this layout when installing.**











#### Planned Products LLC

4699 Nautilus Court South,  
Suite 201  
Boulder, CO 80301-5307 USA

Tel: 303.682.0274  
Fax: 303.682.0678  
Email: [info1@frostfighter.com](mailto:info1@frostfighter.com)  
Web: [www.frostfighter.com](http://www.frostfighter.com)

## Parts List

Part Number: 1202-1725-L

Item	Image	Description	Qty	Item	Image	Description	Qty
011		Defroster element rolls	-	021		Double stick bonding strips 4 in ( 10.6 cm)	2
012		ThermaSync Defrost Control	1	022		Brass buss bars, w/ tab 1 5/8 in (4.12 cm)	2
013		Activation switch	1	023		Brass buss bars, no tab 3 3/8 in (8.57 cm)	1
014		Under dash switch mounting plate	1	024	-	-	-
015		Fuse tap for ATO fuse	1	025		Plastic cover, w/tab slot 1 15/16 in (4.92 cm)	2
016		"T" Tap for connecting power	1	026	-	-	-
017		Female faston connector	1	027		Plastic cover, no tab slot 3 15/16 in (9.84 cm)	1
018		Spade terminal	1	028		GAP-1 Cleaning wipes	1
019		ATO fuse	1	029		Instructions and Attachment	1/1
020		Mounting screws	4	030	-	-	-

## Wire Harness

Please see the electrical and wiring section of the Clear View II full instructions. Not included with Stick Defrosters

### Missing Something? Full or Stick Defroster?

Many Clear View defrosters are available in both full and stick versions.

**Full Defrosters** - Ideal for new installations these defrosters are complete including installation kit that make it easy to install and wire the Clear View II Defrosters.

**Stick Defroster** - Best for defroster replacement. Stick kits include only the defroster and connect to a vehicles existing defroster wiring.

Stick Defrosters DO NOT include the ThermaSync Control, Wire Harness or installation kit including several of the parts listed above.

**See the full Clear View instructions prior to installing any Clear View II defroster.**

### Right or Left Tabs?

Clear View defrosters can be reversed (rotated) as needed for installation.



Planned Products LLC  
4699 Nautilus Court S.  
Suite 201  
Boulder, CO 80301 USA  
Tel: 303.682.0274  
Fax: 303.682.0678  
email: info1@frostfighter.com  
Web: www.frostfighter.com

### Foam Bonding Strip Layout

Please read full instructions before starting work

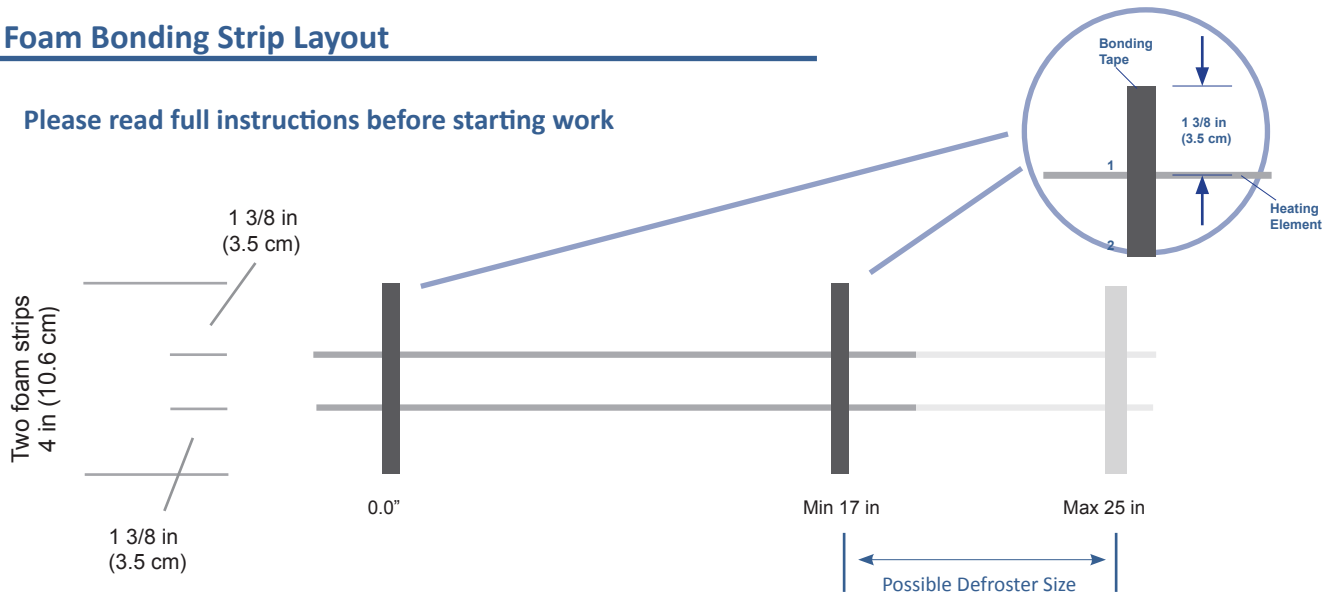

### Order of application

1. Defroster heating elements go down on the window first.
2. Double stick foam bonding strips are applied OVER the defroster elements.
3. Buss bars are bonded in place on the bonding strips.
4. Heating elements are brought over the buss bars with good metal-to-metal contact.
5. Plastic cover is put over elements.

Please read the instructions prior to starting work on the defroster.

#### EXAMPLE ONLY

See layout above and Clear View General instructions

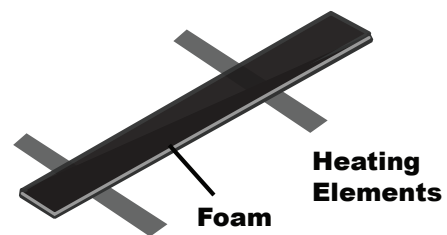

Foam goes on top of defroster elements

**Buss Bar Layout**

Please read full instructions before starting work

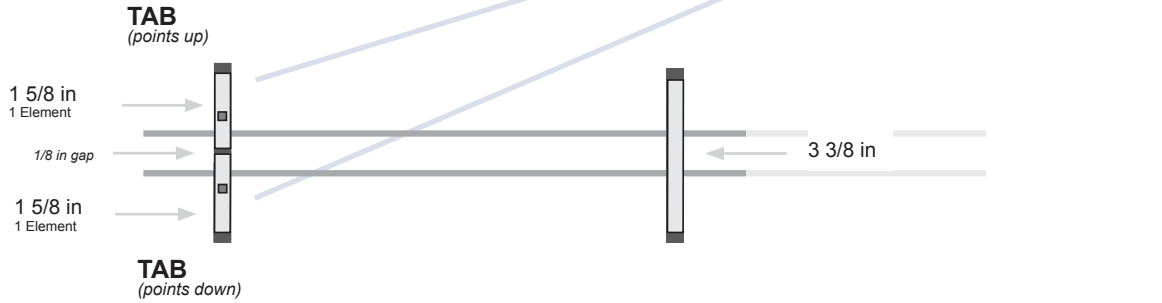

The gap between the buss bars is 1/8 in (32 mm) and is critical.

**Cautions**

The layout shown above is critical to the function of the defroster. All heating elements **MUST** be used in the assembly and connected as shown to the side buss bars. Failure to use all the heating elements or change the layout on the side buss bars **WILL CAUSE THE DEFROSTER TO FAIL.**

See the Clear View Website for additional defroster sizes and ThermaSync defroster controls in 12 and 24 volt.

**EXAMPLE ONLY**

See layout above and Clear View General instructions

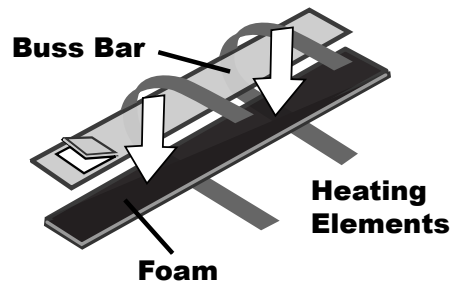

Defroster side buss bars go on top of foam as shown above.

### Cover Layout

Please read full instructions before starting work

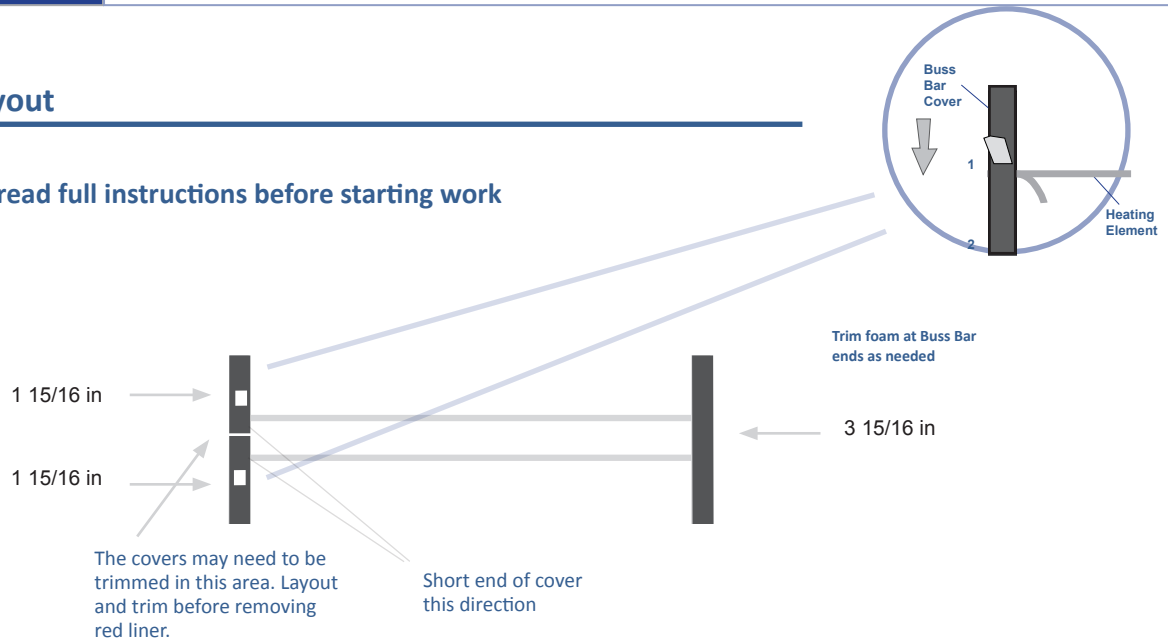

Apply the cover only after the elements have been connected over the buss bar.

### Buss Bar Covers

The buss bar cover bonds the heating elements to the buss bar.

Trimming covers to length may be needed for a perfect fit. It is important to align the covers with the buss bars and apply considerable pressure along the cover once installed to seat it on the buss bar.

Please review both the General Instructions and this attachment prior to installing the Clear View kit.

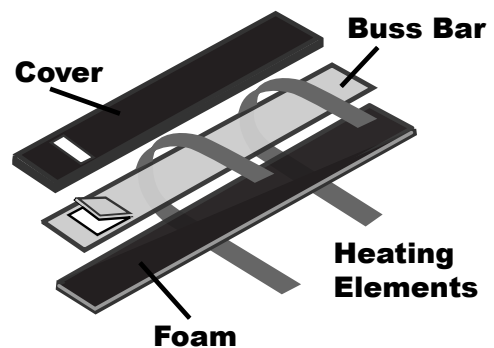

Defroster cover goes over brass buss bar AFTER elements are attached.